

Installation and operating manual

Valid for the following Meyer Burger photovoltaic modules:

MEYER BURGER BLACK - Product type: MB_B120AyB_XXX

MEYER BURGER WHITE - Product type: MB_W120AyB_XXX

MEYER BURGER GLASS - Product type: MB_TG120AyB_XXX

Contents

1. Introduction	2
1.1 General information	2
1.2 Intended use	2
2. Electrical planning, design and wiring	3
2.1 Scope	3
2.2 Certification and technical data of PV modules	4
2.3 Electrical design and planning	4
2.4 Series connection	4
2.5 Parallel connection	4
2.6 Combined connection	4
2.7 Safety during electrical installation	5
2.8 Electrical installation	5
2.9 Equipotential bonding, grounding and lightning protection	5
3. Technical planning and installation of PV modules	6
3.1 Handling and transport	6
3.2 Installation location	6
3.3 Module positioning	7
3.4 Freedom from shade	7
3.5 Substructure	7
3.6 Clamping system	8
3.7 Installation types	9
3.8 Fire protection	15
4. Maintenance and cleaning	15
4.1 Maintenance	15
4.2 Cleaning	15
5. Troubleshooting	16
6. Dismantling and recycling	16

1. Introduction

Congratulations on the purchase of your high-efficiency photovoltaic module (hereinafter referred to as PV module) from Meyer Burger Industries (hereinafter referred to as MBI). Meyer Burger PV modules offer particularly sustainable and climate-friendly energy production, as no greenhouse gases are produced in the solar cells during power generation. MBI strives for sustainable production of PV modules. This is why MBI focuses from the very start on high-quality materials, resource-conserving production processes, maximum recyclability in the sense of the circular economy, reliable and transparent supply chains and optimised transport routes. MBI PV modules enable environmentally friendly conversion of solar energy directly into electrical energy indefinitely and for several decades.



To ensure that you can use the full power of the MBI PV modules, please read and observe the following instructions carefully. Failure to observe the instructions can lead to personal injury and material damage. This installation manual describes the safe installation of the MBI PV modules.

All data and specifications in this installation manual are preliminary and subject to change at any time. The latest version is always available at www.meyerburger.com.

1.1 General information

- Before installing the photovoltaic system (PV system), request information from the relevant local authorities and energy suppliers about the applicable guidelines and approval requirements. Taking these requirements into account is the only way to ensure economic success.



Observe all required local, regional and national (safety) regulations and ordinances, as well as all technical, electrical and structural standards when designing and installing the PV system.

Occupational safety regulations must be observed and occupational health and safety must be guaranteed at all times.



A photovoltaic module is an electrical product. There is a risk of electric shock in the event of incorrect handling and installation. All work may only be carried out by qualified specialist personnel.

- Keep the installation manual for the entire service life of the PV modules.
- Make sure that this installation manual is accessible to the operator at all times.
- Hand over the installation manual to any subsequent owner or user of the PV modules.
- Please observe the other applicable documents.
- Remove the adhesive tape on the rear for securing the cables and connectors before installation.

1.2 Intended use

This installation manual is valid in Africa, Asia, Europe, Latin America and South America. The instructions provide information on how to handle MBI's high-performance crystalline PV modules safely, as well as on installation, assembly, cabling, maintenance and recycling.

NOTE

Deviations from the installation manual and modifications to the module will invalidate the warranty and guarantee. Please refer to the warranty conditions for further details.

2. Electrical planning, design and wiring

2.1 Scope of application

The PV modules are suitable for the following applications:

- Operating ambient temperature -40 °C to +45 °C
- Module operating temperature -40 °C to +85 °C
- Pressure loads of max. 6,000 Pa and tensile loads of max. 4,000 Pa (including safety factor 1.5)*

The assembly takes place on a substructure for PV modules.

* depending on assembly variants (see 3.7 Installation types)



Observe all required local, regional and national (safety) regulations and ordinances, as well as all technical, electrical and structural standards when designing and installing the PV system.

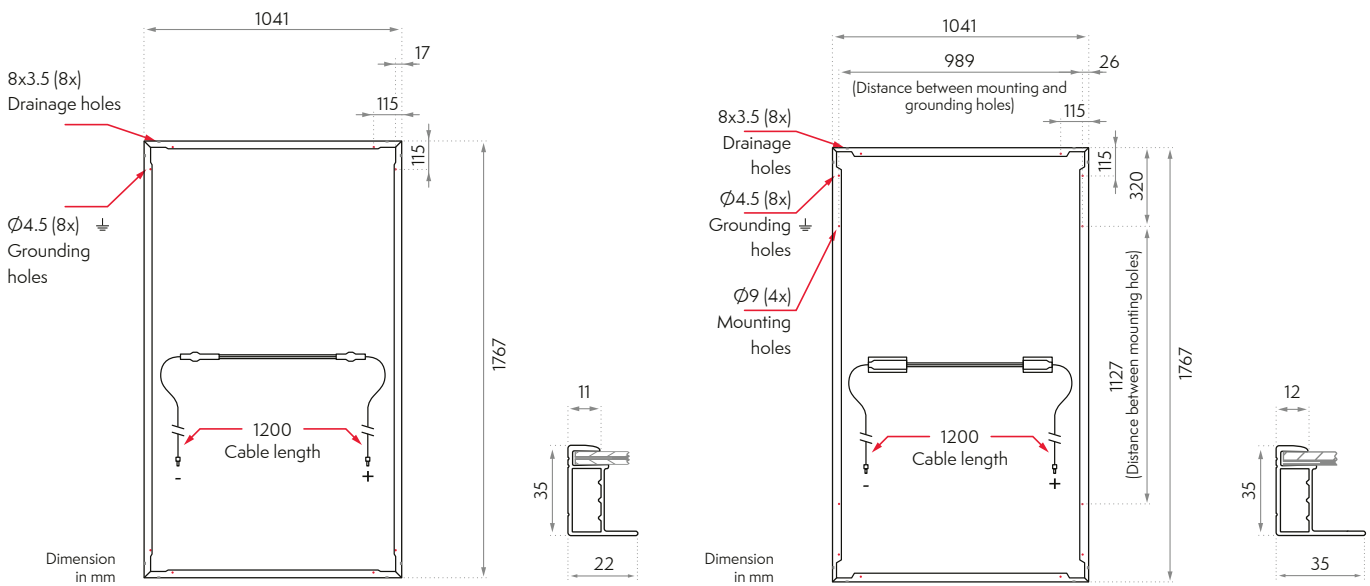

Left side: MEYER BURGER GLASS - Product type: MB_TG120AyB_XXX – Dimensions

Right side: MEYER BURGER BLACK - Product type: MB_B120AyB_XXX / WHITE - Product type: MB_W120AyB_XXX – Dimensions

2.2 Certification and technical data of PV modules

The PV modules are tested and approved according to IEC 61215-2016 and IEC 61730-2016. Please refer to the corresponding data sheets for the further list of current available certificates, as well as all technical and electrical data.

These can be found on our website
www.meyerburger.com.

2.3 Electrical design and planning

- Meyer Burger PV modules have three pre-installed bypass diodes (non-replaceable) that ensure protection and improved performance in the shade.
- It is advisable to only connect PV modules of the same module line and performance class.
- When designing the photovoltaic system (PV system) and its components, a safety factor of 1.25 for the electrical variables (V_{OC} , I_{SC}) must be observed, as a module can supply a higher current and/or higher voltage than under standardised test conditions due to special ambient conditions. For the MEYER BURGER GLASS module, use higher safety factors depending on the application due to the bifaciality.
- It is recommended to use UV resistant PV cables. These must have a minimum cross-section of 4 mm² (12 AWG) and be heat-resistant up to at least 90 °C (194 °F).
- Identical connection plugs (same manufacturer, same plug types) must be used for the extension and connection cables. MBI uses different plug types. These are indicated by numbering on the module label. Please refer to the explanation on the data sheet for the corresponding plug type.
- Shading must be avoided in order to achieve optimal solar radiation and maximise yield.
- The individual system components (PV modules, fuses, inverters, etc.) must be coordinated according to their data sheets.



Observe all required local, regional and national (safety) regulations and ordinances as well as all technical and electrical standards when designing the PV system.

2.4 Series connection

- The PV modules can be connected in series to achieve the desired total voltage.
- The current (I_{MPP}) of the PV modules connected in series should be identical, as the maximum current is determined by the module with the lowest current.
- The maximum system voltage must be observed and can be found in the corresponding module data sheet.

2.5 Parallel connection

- The PV modules can be connected in parallel to achieve the desired total current.
- The voltage (V_{MPP}) of the PV modules connected in parallel should be identical.
- The cable cross-section of the extension cable must be adapted to the maximum current capacity of the wiring.
- To prevent reverse current, an over current protection device is also required (e.g. blocking diodes or string fuse).
- Without string fuse, a maximum of two strings may be connected in parallel. Please observe the value specified in the relevant data sheet for the overcurrent protection rating.

2.6 Combined connection

- All components must be coordinated with each other. The individual connection instructions, series and parallel connection, must be observed.
- The same number of PV modules must be connected in series (identical string voltage).
- Additional safety precautions must be implemented to protect the cables and PV modules from reverse current.



2.7 Safety during electrical installation

The following safety instructions must be observed at all times:

- Work may only be carried out by qualified personnel.
- The applicable safety instructions and regulations must be observed.
- Even with low lighting, the open circuit voltage (Voc) is applied.
- Do not touch the PV modules with bare hands.
- Do not wear metallic jewellery when working with the PV modules.
- Use dry and insulated tools and insulating gloves.
- The PV modules must be dry, clean and free of damage during installation.
- Do not modify the PV modules.
- Never connect or disconnect PV modules under load. There is a risk of electric arc.

2.8 Electrical installation

- The cables and plugs must be routed so that they are protected against moisture.
- The cables and plugs must not lie on the substrate, the roof surface or the ground.
- The cables and plugs must be routed so that they are protected against UV radiation.
- The cables and plugs must be protected against animal bites.
- Connections that are not plugged in must be protected from dirt and moisture during transport, storage and during the installation period, as only plugged-in connections meet their respective protection class.
- Observe the polarity of the cables and plugs during connection.
- PV modules, junction boxes, cables and plugs must be checked for damage and contamination. Only undamaged components may be installed.
- The minimum bending radius of the cable and strain relief must be taken into account.
- The cables must not be routed over sharp edges and corners without protection.

- Always connect the cables with a suitable identical plug, do not trap them and protect them from mechanical stress.
- Ensure that the cables are routed so that there are no loops (minimise the risk of induction during thunderstorms).
- It is recommended to place PV modules with the same orientation and inclination in a string to achieve maximum yields.
- Connect the module string to an inverter suitable for the layout.

2.9 Equipotential bonding, grounding and lightning protection



Proper equipotential bonding of the system components must be ensured in accordance with the locally applicable guidelines, regulations and standards.

The PV module grounding must be implemented in accordance with national, regional and local guidelines, regulations and standards.

- There are grounding holes on the module frames for connecting the PV module grounding and these are marked as such. Please refer to the corresponding module data sheet for the position of the grounding holes.

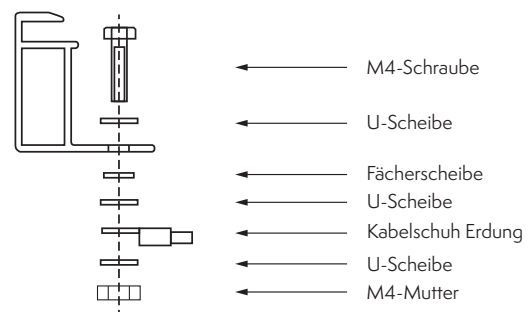

Recommended mounting type for grounding connection



The existing lightning protection concept of the building must be observed. The potential integration of the PV system into the lightning protection concept must be agreed with the corresponding lightning protection expert. National, regional and local guidelines, regulations and standards must be complied with at all times.

3. Technical planning and installation of PV modules

3.1 Handling and transport

- Module pallets should only be loaded and moved using suitable forklifts.
- The forklift truck must have a minimum fork length of 1.20 m, a fork length of 1.75 m is recommended. The forks must be selected and placed so that they do not come into contact with the PV modules under any circumstances.
- Ride over uneven surfaces slowly.
- It is recommended to move the pallets one at a time and not in a double deck.
- Pallets may be stored on a double deck (maximum 2 pallets on top of each other). Only the original Meyer Burger pallets are permitted for stacking. It is essential to ensure that the pallets are positioned exactly on top of each other.
- No third-party products may be placed or stacked on the pallets and PV modules.
- Further transport recommendations can be requested from Meyer Burger.
- The PV modules may only be touched on the module frame with clean gloves.
- When unpacking the PV modules, the front side must be protected against scratches, etc.
- The cables of the PV modules must not be short-circuited (connected) under any circumstances.
- It is prohibited to handle and carry the module by the cables and junction boxes.
- Climbing on the PV modules and other point loads (e.g. carrying the PV modules by their head or back) is prohibited, as this can lead to irreversible damage to the PV modules.
- Do not place tools or other objects on top of or drop them onto the PV modules.
- The PV modules must be stored dry and protected from the weather until installation. The transport pallets do not provide sufficient protection for outdoor storage of the PV modules.
- When unpacking the PV modules from the pallet, the stability of the PV modules and pallet must be ensured. The pallet and PV modules must be secured against falling over.
- The packaging must be disposed of properly.

3.2 Installation location

The following information on the installation location must be observed:

The PV modules must **not** be installed:

- In enclosed spaces
- Over 2,000 m above sea level*
- On water surfaces*
- In places where water can accumulate (e.g. flooding)
- Near highly flammable gases or vapours (e.g. gas tanks or filling stations)
- In places where contact of chemical substances (e.g. oil or solvents) with parts of the PV module is possible
- Near open flames or flammable/explosive materials
- In the immediate vicinity of air conditioning and ventilation systems
- The PV modules must not be used as a replacement for roof coverings or facades.
- For installations closer than 500 m to the sea, special precautions must be taken with regard to grounding, maintenance and cleaning.
- The PV modules must not be in direct contact with salt water.
- There is an increased risk of corrosion when installing PV modules in salty or ammonia/sulphurous environments.
- Use of PV modules on mobile units such as vehicles and ships will void any liability and warranty claims.
- The use of PV modules for BIPV applications (building-integrated photovoltaics) is not permitted*.
- The use of PV modules in concentrated light applications is prohibited.

* Installation above 2,000 m above sea level, on water surfaces or in BIPV applications requires consultation with and explicit approval from the manufacturer.

3.3 Module positioning

- The PV modules can be installed in landscape or portrait format.
- Ensure that there is no water build-up. Rain and melt water must be able to drain freely.
- The drainage openings in the module frame must not be covered or sealed.
- The PV modules must be installed with a minimum inclination angle of 5°.
- The maximum permitted inclination angle must be determined in accordance with the locally applicable regulations.
- An inclination angle greater than 20° has a positive effect on the self-cleaning of the PV modules.
- There must be no objects (air outlets, antennas, etc.) on the back of the module that could lead to point loads when the PV modules bend.



Local, country-specific building regulations must be observed.

3.4 Freedom from shade

Optimal solar radiation results in maximum energy yield:

- Install the front of the PV modules facing the solar radiation. The electrical connection box is located on the rear of the PV module.
- Shading and partial shading (e.g. trees, chimneys, buildings, dirt, snow, overhead lines etc.) should be avoided.
- In the case of bifacial PV modules, it must be ensured that shading caused by the substructure on the rear of the module is avoided or minimised.
- In the case of strong or inhomogeneous shading, the use of optimizers in the system may be advantageous.

3.5 Substructure

- The structure or subsurface on which the PV system is installed must be able to absorb the resulting static loads.
- The substructure must be able to absorb the forces acting on the module.
- The statics of the substructure must be designed according to the local snow and wind loads.
- In addition to the wind and snow loads, no forces may act on the module via the substructure.
- The substructure must be properly fixed to the roof or the floor.
- Uneven snow loads (e.g. snow overhangs, snowdrifts) that lead to local increases in loads must be eliminated or prevented by technical measures.
- The substructure must ensure adequate cooling through rear ventilation of the PV modules.
- The fixing must be stress-free to allow for temperature-related changes in length.
- A minimum distance of 5 mm between the PV modules is recommended.
- The PV modules can be fastened using clamps or insert rails. The MEYER BURGER WHITE and MEYER BURGER BLACK PV modules can also be fastened using a screw connection (point connection) (see table in Section 3.7).
- There must be no components between the profiles of the substructure and the PV modules.
- Sharp edges and point loads of the substructure under the PV modules must be avoided.
- Additional stresses and torques at the mounting positions are not permitted. It must be ensured that the clamps or insertion rails do not touch the glass, even under load.
- A distance of at least 50 mm from the substructure and other hard structures under the junction box (except for mounting variant CP2) must be ensured.
- Make sure that the cables cannot be pinched between laminate and carrier rail under high compression load. Routing the cable along the module frame is recommended.
- Contact between different metallic materials must be avoided (contact corrosion, observe electrochemical series), e.g. it must be ensured that the fastening screws and washers have the same material properties.
- Corrosion-resistant screws and washers must be used for installation.

3.6 Clamping system

Clamps that meet the following requirements must be used:

- Minimum clamping width 40 mm
 - Clamping height for 35 mm frame height
 - Clamping depth 7–11 mm
 - Static requirements of the respective site
 - Long-term stable clamps
-
- The clamps must not touch the front glass.
 - The clamps must not cast shade on any cells.
 - The clamps must not damage or deform the frame of the module.
 - Clamps must be attached to the substructure as specified by the substructure manufacturer, including specific hardware and torque requirements. A maximum torque of 20 Nm must not be exceeded.
 - The module frame must not be removed or modified. Drilling additional holes on the module frame is not permitted. Changes of any kind will void the warranty.

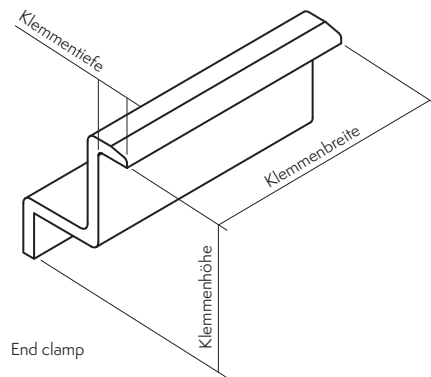

End clamp

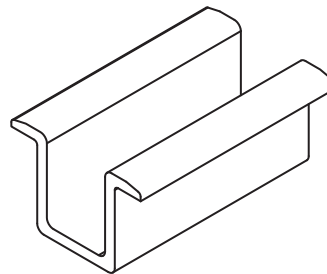

Middle clamp

Example of end and middle clamp

3.7 Installation types

The overview table shows all permissible installation types including the associated test loads according to IEC 61215. The following tables show in detail the different assembly variants (sketches), the permissible associated fixing areas

and the corresponding maximum pressure and suction loads. Suitable fastening variants can be developed in consultation with MBI for assembly with unspecified installation types or with increased loads.

Module			Installation type			Design load		Test load*	
WHITE	BLACK	GLASS	Name	L [mm]	W [mm]	Pressure [Pa]	Suction [Pa]	Pressure [Pa]	Suction [Pa]
x	x	x	CP1	320		4000	2666	6000	4000
				200 - 450		3600	1600	5400	2400
				0 - 550		1600	1600	2400	2400
x	x	x	CP1a	200 - 450		3200	1600	4800	2400
				0 - 550		1600	1600	2400	2400
x	x	x	CP2		160 - 210	1600	1600	2400	2400
x	x	x	CP2a		0 - 300	1600	1600	2400	2400
x	x	x	CL1	320		3600	2666	5400	4000
				200 - 450		3600	1600	5400	2400
				0 - 550		1600	1600	2400	2400
x	x	x	CL2		0 - 300	1600	1600	2400	2400
x	x	x	IP1			3600	2666	5400	4000
x	x	x	IP2			1600	1600	2400	2400
x	x		MP1	320		4000	2666	6000	4000
x	x		MP1a	320		3600	1600	5400	2400

*Test load = 1.5 x Design load (according to IEC 61215)

Legend:

CP: Clamp point

CL: Clamp line

MP: Mounting point on frame

IP: Installation profile/Insertion profile

...1: Installation on long module side

...2: Installation on short module side

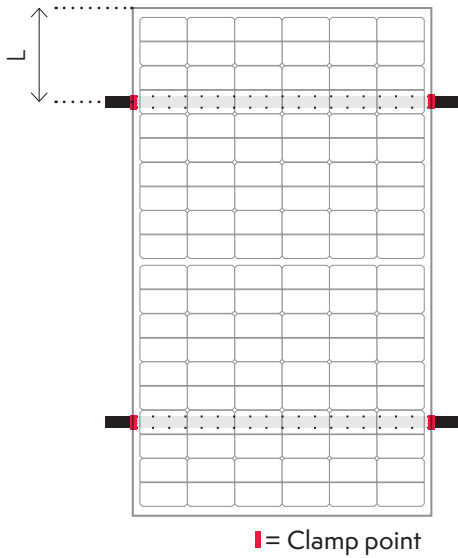

INSTALLATION TYPE CP1

Fastening with 4 module clamps on the long module side, point mounting with continuous substructure rails

PERMISSIBLE LOADS (PRESSURE, SUCTION)

CP1		Design load		Test load (1.5x safety)	
Module	L [mm]	Pressure [Pa]	Suction [Pa]	Pressure [Pa]	Suction [Pa]
WHITE, BLACK, GLASS	320	4000	2666	6000	4000
	200 - 450	3600	1600	5400	2400
	0 - 550	1600	1600	2400	2400

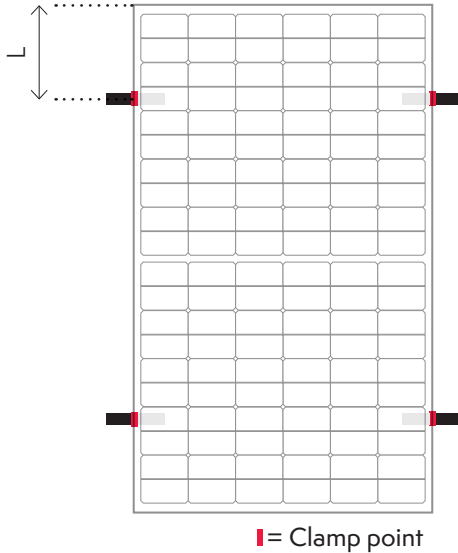

INSTALLATION TYPE CP1a

Fastening with 4 module clamps on the long module side, point mounting without continuous substructure rails

PERMISSIBLE LOADS (PRESSURE, SUCTION)

CP1a		Design load		Test load (1.5x safety)	
Module	L [mm]	Pressure [Pa]	Suction [Pa]	Pressure [Pa]	Suction [Pa]
WHITE, BLACK, GLASS	200 - 450	3200	1600	4800	2400
	0 - 550	1600	1600	2400	2400

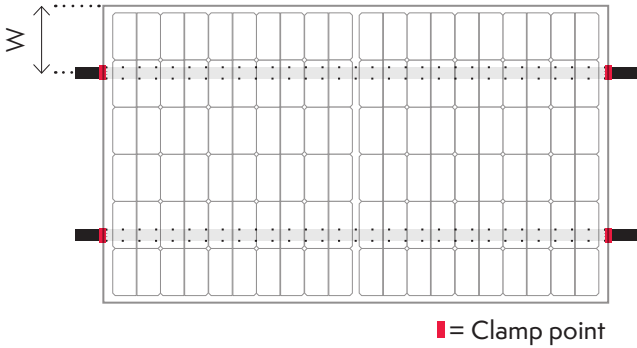
INSTALLATION TYPE CP2

Fastening with 4 module clamps on the short module side, point mounting with continuous substructure rails

PERMISSIBLE LOADS (PRESSURE, SUCTION)

Module	CP2 W [mm]	Design load		Test load (1.5x safety)	
		Pressure [Pa]	Suction [Pa]	Pressure [Pa]	Suction [Pa]
WHITE, BLACK, GLASS	160 - 210	1600	1600	2400	2400

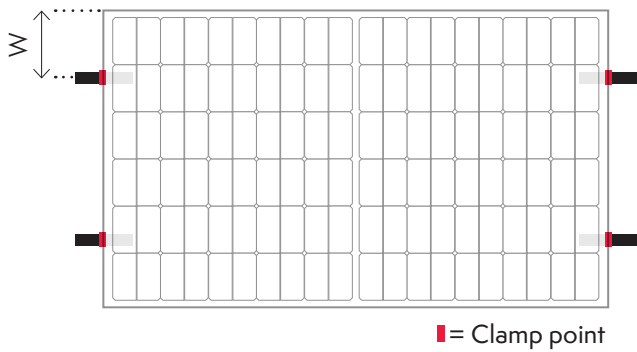
INSTALLATION TYPE CP2a

Fastening with 4 module clamps on the short module side, point mounting without continuous substructure rails

PERMISSIBLE LOADS (PRESSURE, SUCTION)

Module	CP2a W [mm]	Design load		Test load (1.5x safety)	
		Pressure [Pa]	Suction [Pa]	Pressure [Pa]	Suction [Pa]
WHITE, BLACK, GLASS	0-300	1600	1600	2400	2400

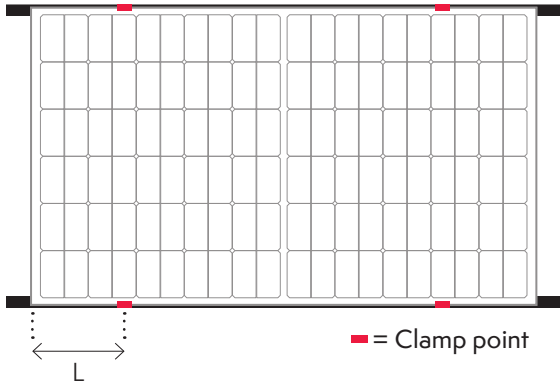
INSTALLATION TYPE CL1

Fastening with 4 module clamps on the long module side,
line mounting along the long module side

PERMISSIBLE LOADS (PRESSURE, SUCTION)

CL1		Design load		Test load (1.5x safety)	
Module	L [mm]	Pressure [Pa]	Suction [Pa]	Pressure [Pa]	Suction [Pa]
WHITE, BLACK, GLASS	320	3600	2666	5400	4000
	200 - 450	3600	1600	5400	2400
	0 - 550	1600	1600	2400	2400

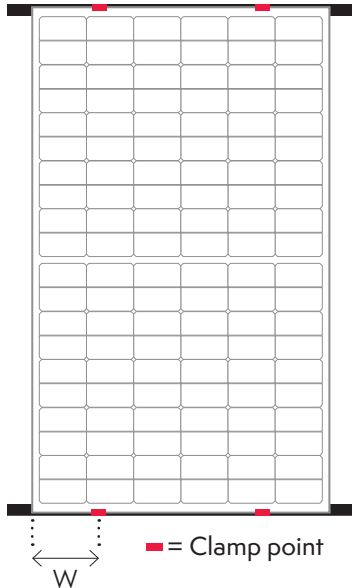
INSTALLATION TYPE CL2

Fastening with 4 module clamps on the short module side,
line mounting along the short module side

PERMISSIBLE LOADS (PRESSURE, SUCTION)

CL2		Design load		Test load (1.5x safety)	
Module	W [mm]	Pressure [Pa]	Suction [Pa]	Pressure [Pa]	Suction [Pa]
WHITE, BLACK, GLASS	0 - 300	1600	1600	2400	2400

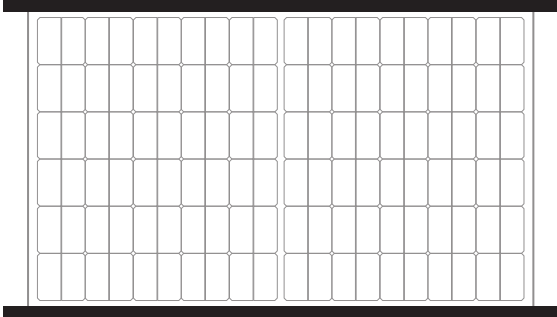
INSTALLATION TYPE IP1

Fastening via line mounting with insert profile rails
on the long module side

PERMISSIBLE LOADS (PRESSURE, SUCTION)

IP1 Module	Design load		Test load (1.5x safety)	
	Pressure [Pa]	Suction [Pa]	Pressure [Pa]	Suction [Pa]
WHITE, BLACK, GLASS	3600	2666	5400	4000

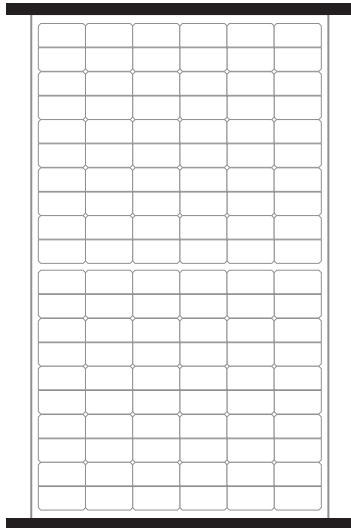
INSTALLATION TYPE IP2

Fastening via line mounting with insert profile rails
on the short module side

PERMISSIBLE LOADS (PRESSURE, SUCTION)

IP2 Module	Design load		Test load (1.5x safety)	
	Pressure [Pa]	Suction [Pa]	Pressure [Pa]	Suction [Pa]
WHITE, BLACK, GLASS	1600	1600	2400	2400

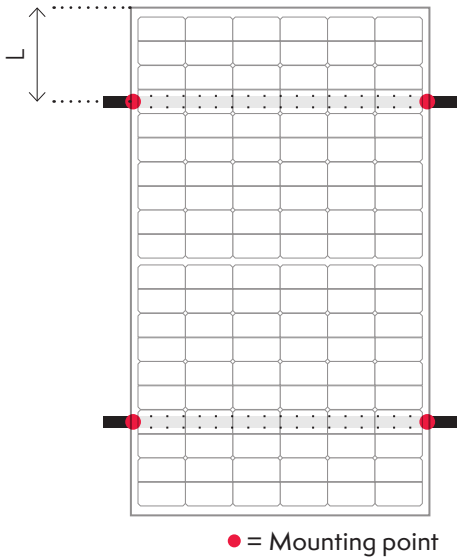
INSTALLATION TYPE MP1

Fastening to the mounting points on the long module side, point mounting with continuous substructure rails

PERMISSIBLE LOADS (PRESSURE, SUCTION)

Module	MP1	Design load		Test load (1.5x safety)		
		L [mm]	Pressure [Pa]	Suction [Pa]	Pressure [Pa]	Suction [Pa]
WHITE, BLACK		320	4000	2666	6000	4000

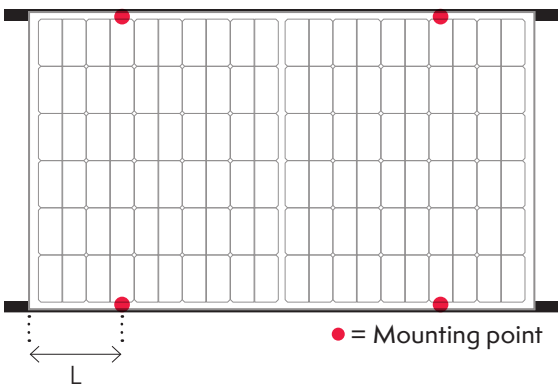
INSTALLATION TYPE MP1a

Fastening at the mounting points on the long module side, line mounting along the long module side

PERMISSIBLE LOADS (PRESSURE, SUCTION)

Module	MP1a	Design load		Test load (1.5x safety)		
		L [mm]	Pressure [Pa]	Suction [Pa]	Pressure [Pa]	Suction [Pa]
WHITE, BLACK		320	3600	1600	5400	2400

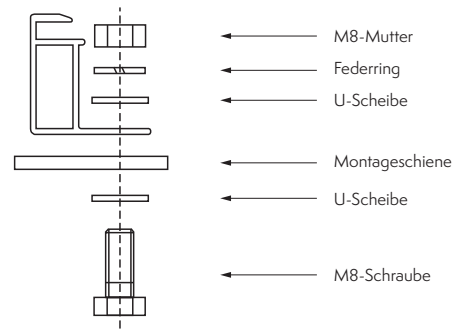

Recommended mounting method at the mounting points of the MP1 and MP1a installation variants

3.8 Fire protection

- When installing on the roof, the PV modules may only be installed over a fire-resistant roof cover ("hard roof"). This excludes the in-roof installation of the PV modules.



Improper installation can lead to fires/ fire hazards. Observe all necessary local, regional and national building and fire protection regulations, ordinances as well as all technical, electrical and structural standards when designing and installing the PV system.

4. Maintenance & cleaning

4.1 Maintenance

- It is recommended to have the system checked regularly (annually) by an installer. The inspection interval may vary depending on local circumstances/conditions/regulations.
- Check glass surface, frame and connections for damage.
- Check the electrical components for corrosion and good connection contact.
- If a module needs to be replaced, observe the instructions for disassembly and assembly (see Sections 3 and 6). The replacement module should have the same electrical properties.
- After an unusual weather event (storm, hail, a lot of snow, etc.), the modules must be checked for damage.
- The vegetation under the PV modules must be cut back regularly to avoid shading on the PV modules.

4.2 Cleaning

- Use sufficient water and a soft cloth to clean the PV modules.
- The PV modules must only be cleaned manually.
- Do not use high-pressure cleaners for cleaning.
- Allow the PV modules to cool down before cleaning.
- Never touch glass with bare hands as this may leave fingerprints.
- The use of aggressive cleaners, ethanol and isopropanol, diluted alcohol, acetone and any chemical cleaning agents is not permitted, as this may damage the anti-reflective coating (ARC) of the module.
- The use of acids, alkalis, bleach powders and strong bases is not permitted.
- The ingredients of cleaning products should be checked before use.
- Do not use deionized water for cleaning.
- The use of abrasive cleaning agents such as sanding powder, steel wool, scrapers and steel cleaning equipment is not permitted.
- Care should be taken when cleaning if sand or heavy soiling is present to avoid scratches.
- To remove heavy soiling, use generous amounts of water before wiping the glass surface. Stubborn dirt should be soaked if necessary.
- Carefully remove leaves, snow, ice or other loose dirt with a soft broom.
- Damage to the anti-reflective coating (ARC) due to improper cleaning will void the performance warranty.

5. Troubleshooting



The installer or the technical customer service of MBI must be contacted in the event of a malfunction of the PV system. Never try to remedy the fault yourself, especially in the event of glass breakage. There is a risk of electric shock.



Contact details can be found at www.meyerburger.com

6. Dismantling and recycling

- When disassembling the system, the (dis)assembly/ installation manual for the other installed system components must be observed.



The work may only be carried out by qualified personnel.

- The five safety rules of electrical engineering must be observed.
- The inverter must be switched off and its switch-off time interval observed.
- The PV modules must be disconnected from the inverter. It is essential to ensure and check that the inverter is de-energised.
- The plugs must only be disconnected with suitable specialist tools.
- Check the components for damage.

Meyer Burger (Industries) GmbH

Carl-Schiffner-Strasse 17
09599 Freiberg
Germany

www.meyerburger.com

- PV modules and substructure must be disassembled with suitable specialist tools.
- PV modules and other components must be packaged for safe transport.
- The modules must be disposed of in accordance with local regulations.
- The following applies in Germany: PV modules are collected at recycling centres and recycled by our partner take-e-way. www.take-e-way.de